

2018 Summit County Open Show Series

English Showmanship (Classes 3-5 Ring A)

Show Date: 09-15-2018

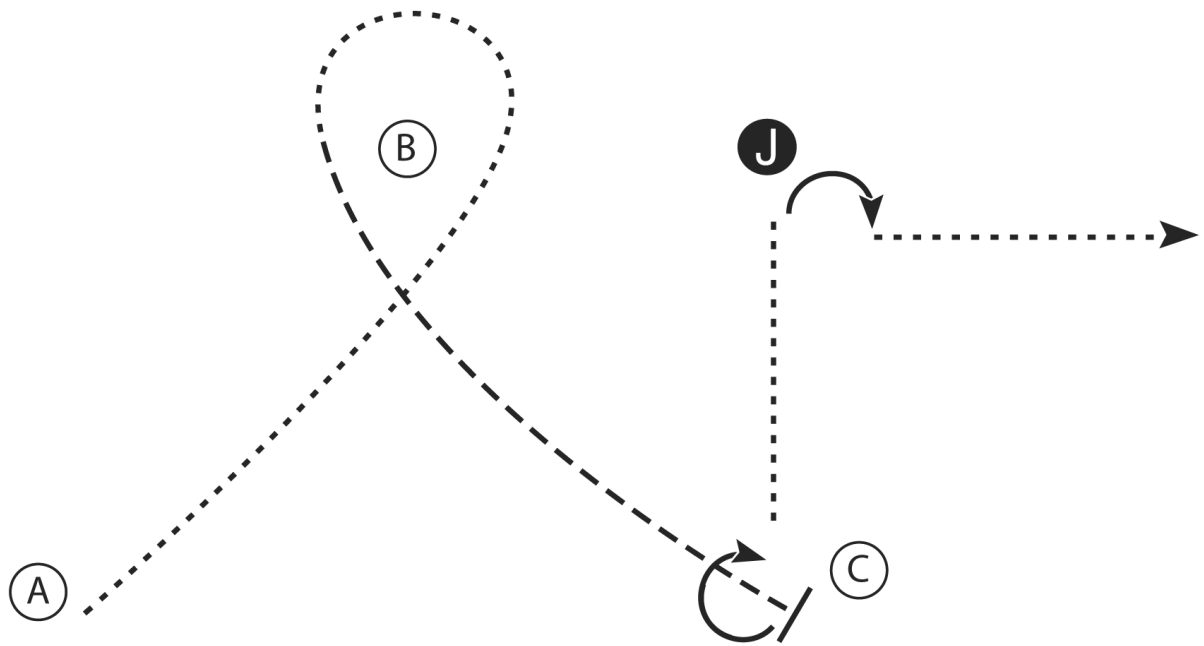

1. Walk A to and around B
2. At B trot to C
3. Stop at C and perform a 225 degree turn
4. Walk to the judge and set up for inspection
5. When dismissed perform a 90 degree turn and walk straight away from the judge

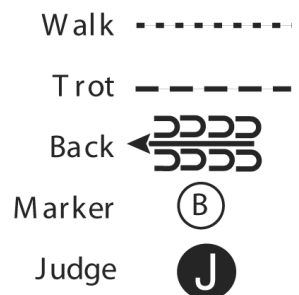

[S/1-1]

Pattern Provided by:
Emily S. Wilson

2018 Summit County Open Show Series

Showmanship (Classes 6-8 Ring A and 12-13 Ring B)

Show Date: 09-15-2018

w w w . H o r s e S h o w P a t t e r n s . c o m

w w w . H o r s e S h o w P a t t e r n s . c o m

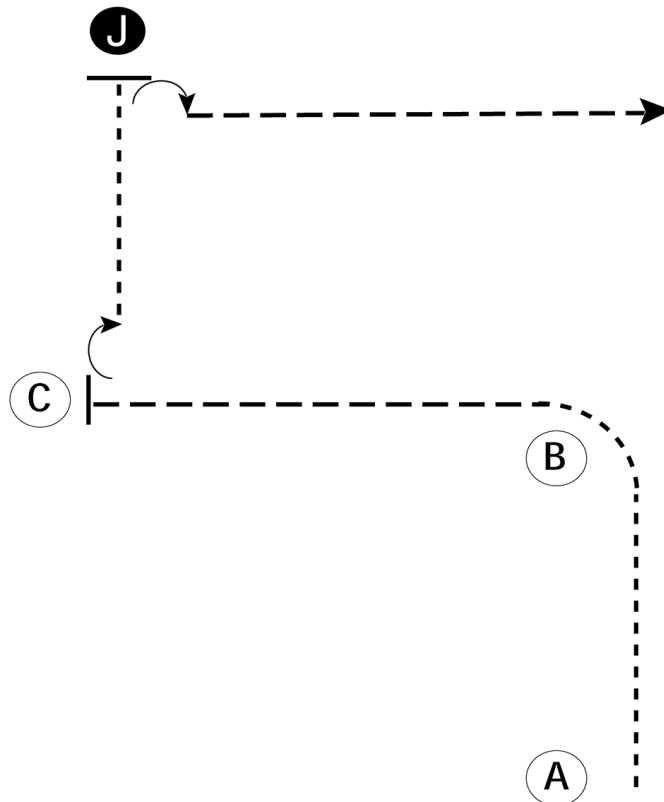

Be ready at A.

1. Walk from A to B.
2. Trot from B to C.
3. Stop at C and perform a 90 degree turn.
4. Walk to the judge.
5. Stop and set up for inspection.
6. When dismissed, perform a 90 degree turn.
7. Trot away from judge.
8. Follow the instructions of your ring steward.

Walk	-----
Trot	- - - - -
Back	←
Marker	ⓑ
Judge	ⓐ

[S/WT-17]

Pattern Provided by:
Emily S. Wilson

2018 Summit County Open Show Series

Western Showmanship (Classes 9-11 Ring A)

Show Date: 09-15-2018

w w w . H o r s e S h o w P a t t e r n s . c o m

w w w . H o r s e S h o w P a t t e r n s . c o m

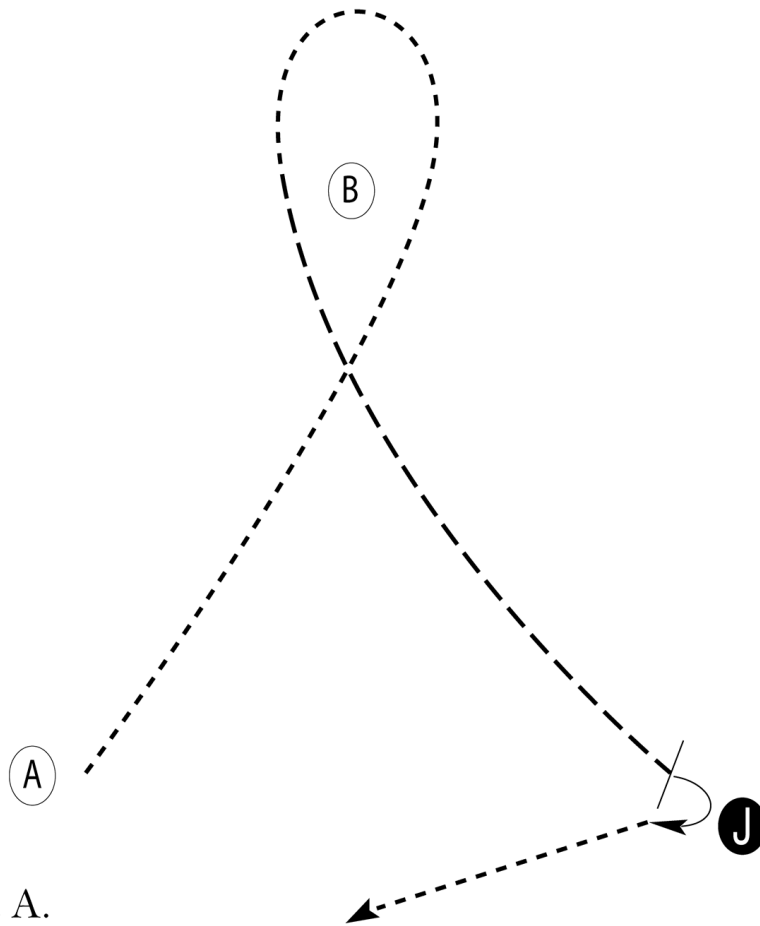

Be ready at A.

1. Walk from A to and around B.
2. Trot from B to the judge.
3. Stop and set up for inspection.
4. When dismissed, turn approximately 90 degrees and follow the instructions of your ring steward.

Walk	-----
Trot	- - - - -
Back	←
Marker	ⓑ
Judge	ⓙ

[S/WT-6]

Pattern Provided by:
Emily S. Wilson

2018 Summit County Open Show Series

English Equitation (Classes 17-19 Ring A)

Show Date: 09-15-2018

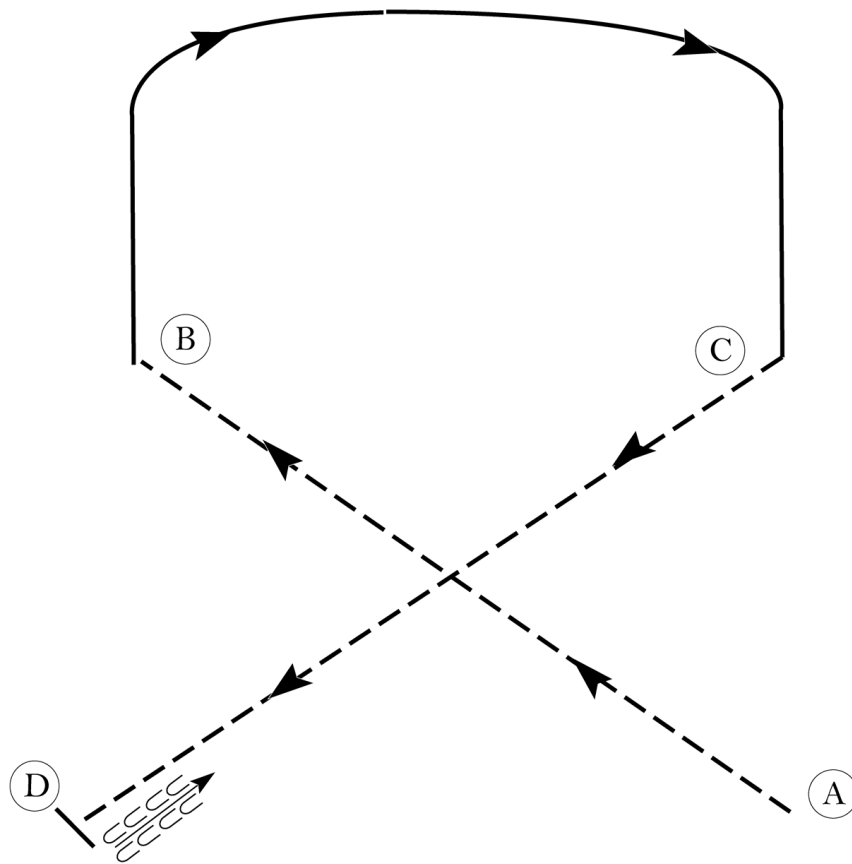

Be ready at A.

1. Posting trot on the left diagonal to B.
2. Canter right lead to C.
3. Posting trot on the right diagonal 1/2 way to D.
4. Sitting trot to D.
5. Halt at D and back approximately one horse length.

Exit at a sitting trot.

Walk	-----
Trot	- - - - -
Extended Trot	— — — — —
Canter	—————
Leg Yield	
Lead Change	— / —
Back	← ← ← ← ←
Marker	(B)
Sidepass	← ← ← ← ←
Hand Gallop	— — — — —

[HSE/1-23]

Pattern Provided by:
Emily S. Wilson

w w w . H o r s e S h o w P a t t e r n s . c o m

w w w . H o r s e S h o w P a t t e r n s . c o m

2018 Summit County Open Show Series

Western Horsemanship (Classes 29-31 Ring A)

Show Date: 09-15-2018

w w w . H o r s e S h o w P a t t e r n s . c o m

w w w . H o r s e S h o w P a t t e r n s . c o m

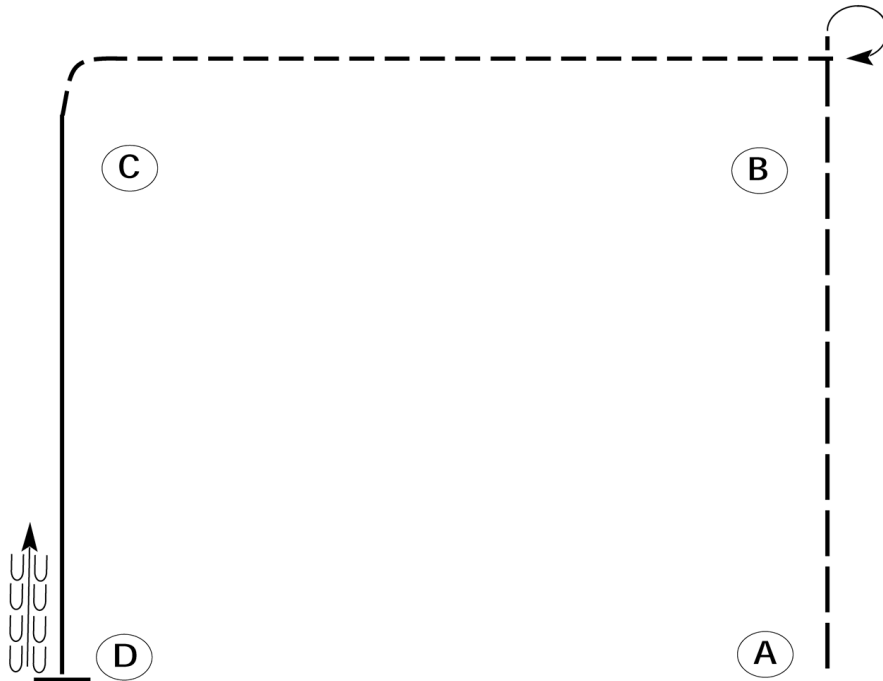

Be ready at A.

1. Extended jog from A to B.
2. Stop past B and execute a 270 degree turn to the right.
3. Jog from B around C.
4. Lope on the left lead from C to D.
5. Stop at D and back one horse length.

Please exit at a jog.

Walk
Jog	-----
Extended Jog	- - - - -
Lope	—————
Leg Yield	
Lead Change	///
Back	←←←←←
Marker	⊙ B
Sidepass	←-----→

[WH/1-23]

Pattern Provided by:

Emily S. Wilson

2018 Summit County Open Show Series

Adult Walk Trot EQ/HMS (Class 50 Ring B)

Show Date: 09-15-2018

w w w . H o r s e S h o w P a t t e r n s . c o m

w w w . H o r s e S h o w P a t t e r n s . c o m

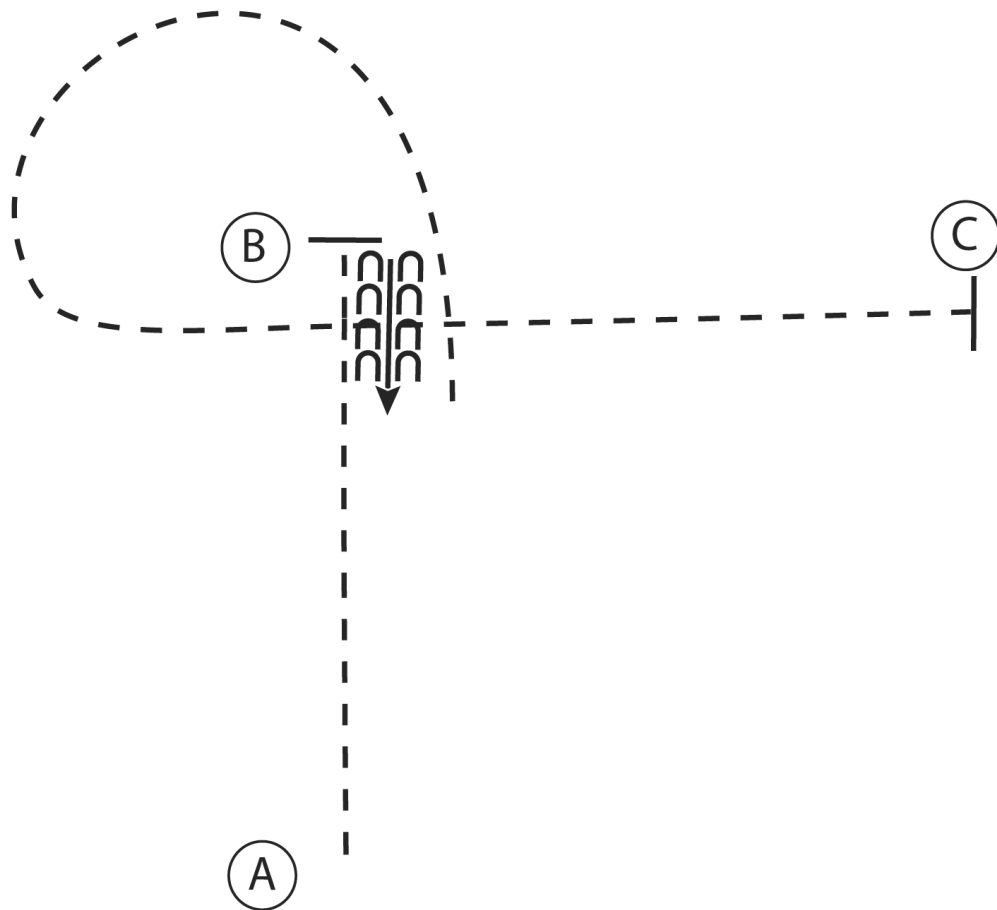

1. Trot A to B
2. At B stop and back 4 steps
3. Trot a circle around B and continue to C
4. Stop at C

Walk
Trot	-----
Extended Trot	-----
Canter	—————
Leg Yield	
Lead Change	↘
Back	← C C C C ← C C C C
Marker	(B)
Sidepass	←-----←

[HSE/WT-2]

Pattern Provided by:
Emily S. Wilson

2018 Summit County Open Show Series

Youth Walk Trot English Equitation (Class 53 Ring B)

Show Date: 09-15-2018

w w w . H o r s e S h o w P a t t e r n s . c o m

w w w . H o r s e S h o w P a t t e r n s . c o m

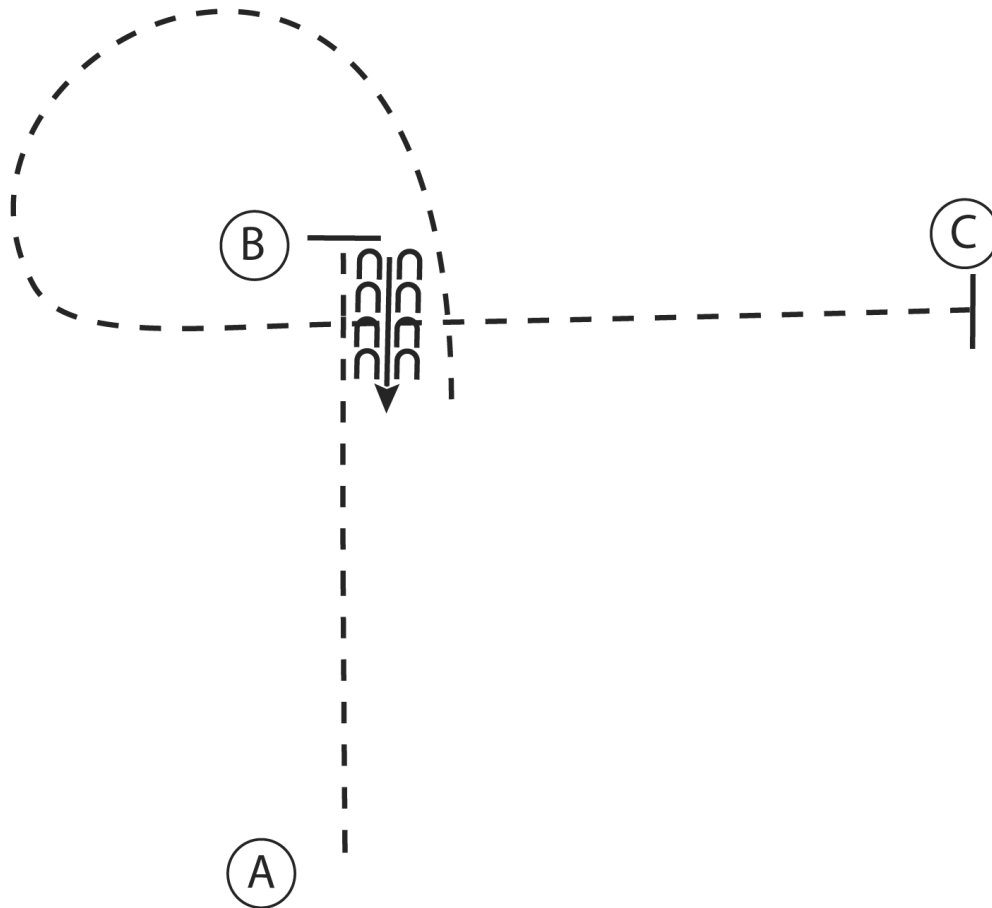

1. Trot A to B
2. At B stop and back 4 steps
3. Trot a circle around B and continue to C
4. Stop at C

Walk
Trot	-----
Extended Trot	-----
Canter	—————
Leg Yield	
Lead Change	↘
Back	←←←←←
Marker	(B)
Sidepass	←-----←

[HSE/WT-2]

Pattern Provided by:

Emily S. Wilson

2018 Summit County Open Show Series

Small Equine Hunter and Jumper In Hand (Classes 56-57 Ring B)

Show Date: 09-15-2018

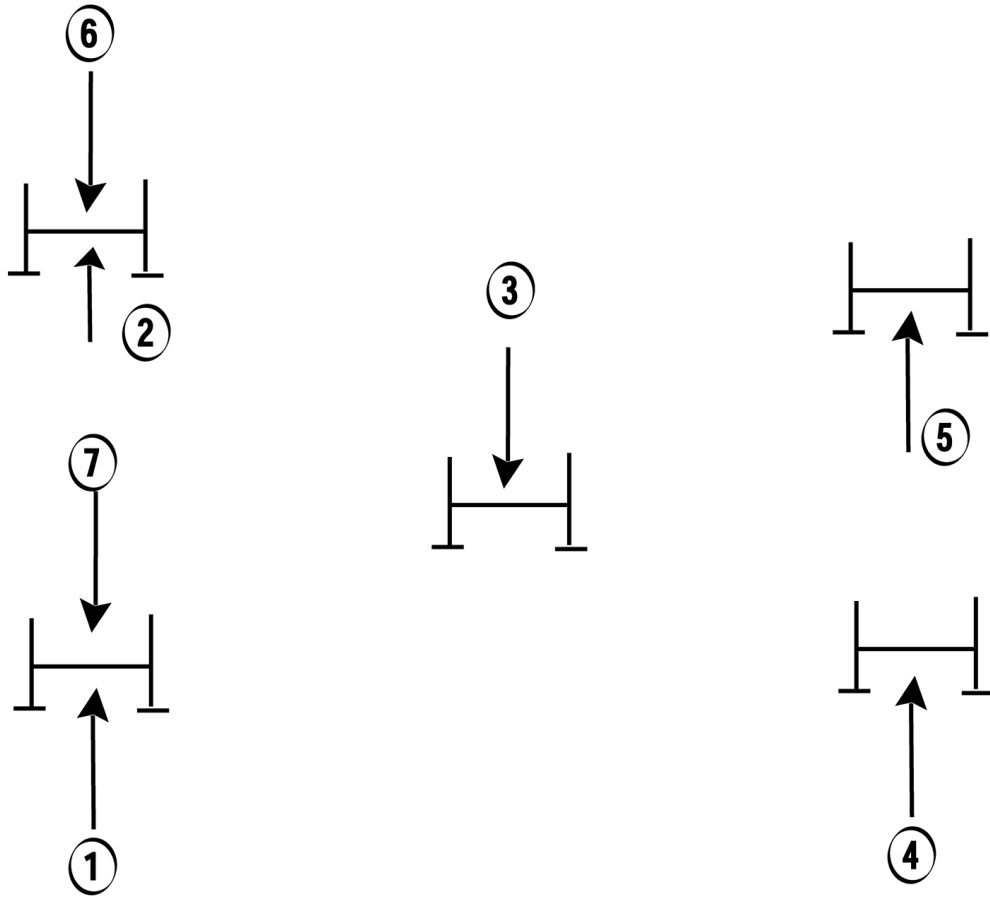

w w w . H o r s e S h o w P a t t e r n s . c o m

w w w . H o r s e S h o w P a t t e r n s . c o m

[MHP/H-7]

Pattern Provided by:

Emily S. Wilson

2018 Summit County Open Show Series

Youth Walk Trot Western Horsemanship (Class 60 Ring B)

Show Date: 09-15-2018

w w w . H o r s e S h o w P a t t e r n s . c o m

w w w . H o r s e S h o w P a t t e r n s . c o m

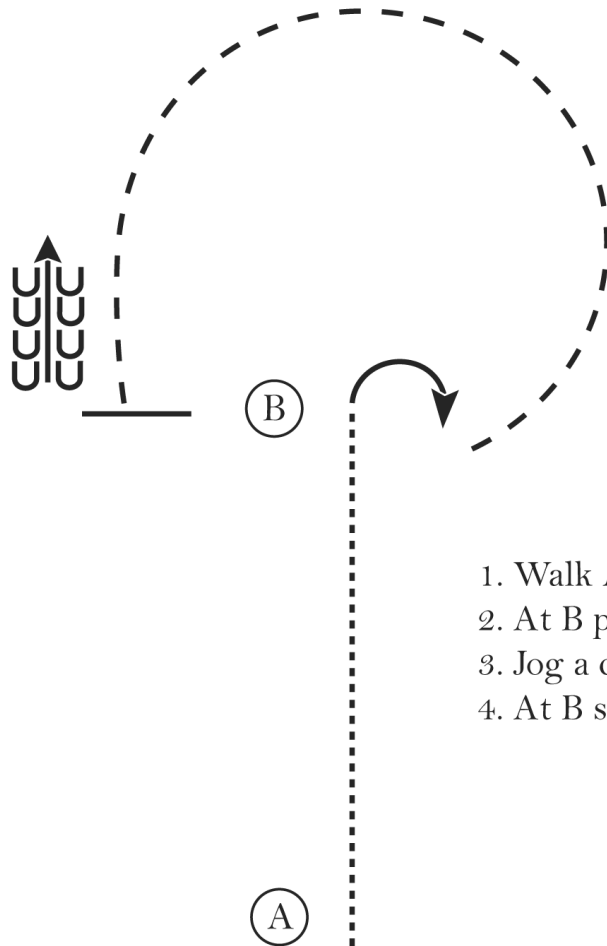

1. Walk A to B
2. At B perform a 90 degree turn to the right
3. Jog a circle around B
4. At B stop and back 4 steps

Walk
Jog	-----
Extended Jog	- - - - -
Lope	—————
Leg Yield	
Lead Change	↘
Back	←←←←← ←←←←←
Marker	(B)
Sidepass	←←←←←

[WH/WT-7]

Pattern Provided by:

Emily S. Wilson

2018 Summit County Open Show Series

Leadline Walk Trot Equitation E/W (Class 61 Ring B)

Show Date: 09-15-2018

w w w . H o r s e S h o w P a t t e r n s . c o m

w w w . H o r s e S h o w P a t t e r n s . c o m

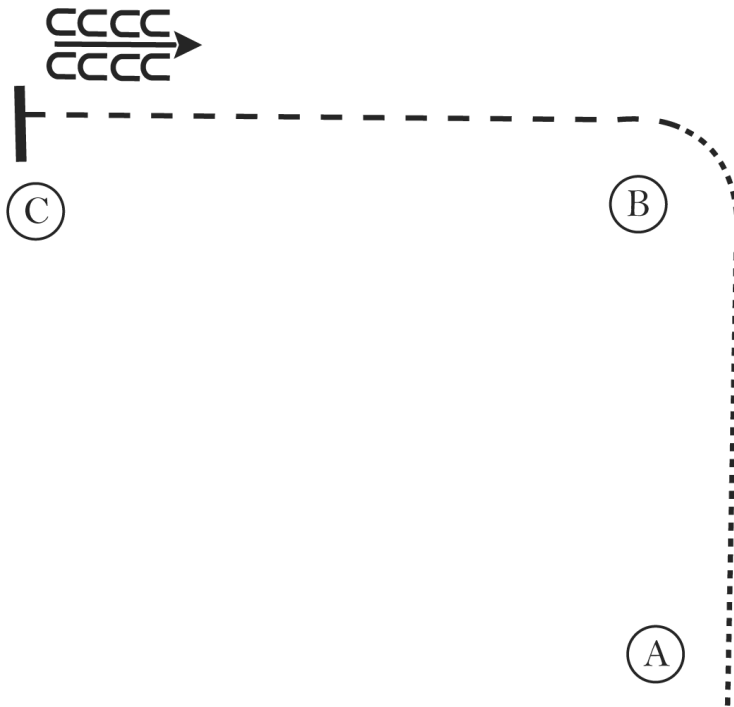

1. Walk A to B
2. Jog B to C
3. At C stop and back

Walk	
Jog	
Extended Jog	
Lope	
Leg Yield	
Lead Change	
Back	
Marker	
Sidepass	

[WH/WT-4]

Pattern Provided by:
Emily S. Wilson